



# The eEvidence Digital Exchange System

Vision for 2031

What is an e-CODEX network?

# e-CODEX network

# e-CODEX Regulation

e-Delivery Gateway – Secure Transmission – **DIGIT**

e-CODEX Connector – **eu-LISA** – connects Reference Implementation or National Systems

e-CODEX Access Point = Connector + Gateway  
**eu-LISA**

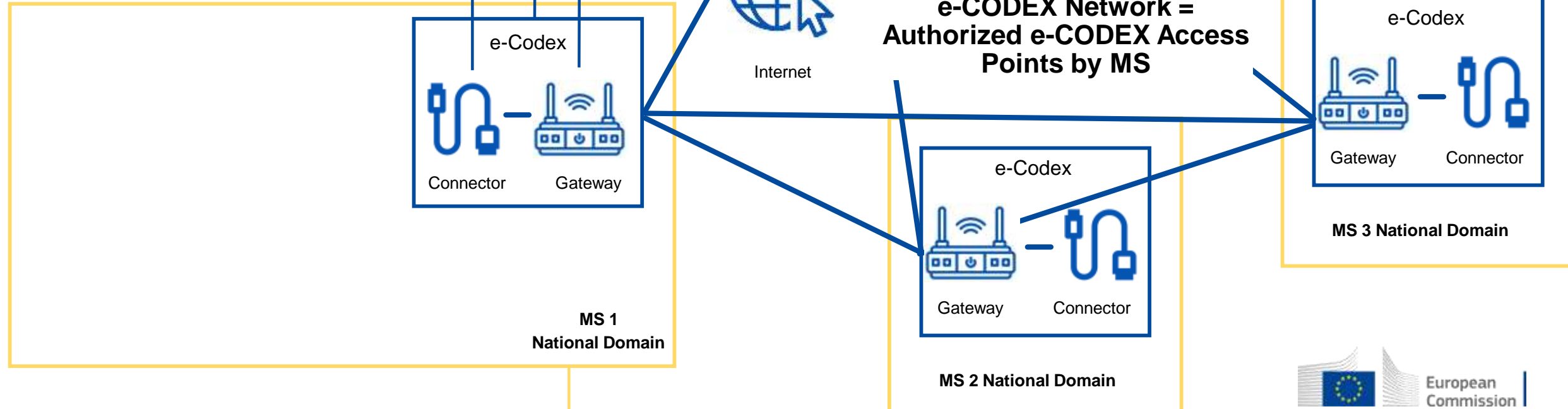

**MS** Full Responsibility Operations/Maintenance – Support to MS: **eu-LISA**

**MS Communicate to eu-LISA their Authorized Access Points**  
**eu-LISA – Enrol the APs**



# What is a Digital Exchange System?

# What is a Digital Exchange System?

A network of national (case management) systems and/or Reference Implementation(s) connected to the same e-CODEX network and supporting document exchanges within the same cross-border judicial procedures.

# e-CODEX network

# e-CODEX Regulation

e-Delivery Gateway – Secure Transmission – **DIGIT**

e-CODEX Connector – **eu-LISA** – connects Reference Implementation or National Systems

e-CODEX Access Point = Connector + Gateway  
**eu-LISA**

**MS Communicate to eu-LISA their Authorized Access Points**

**eu-LISA – Enrol the APs**

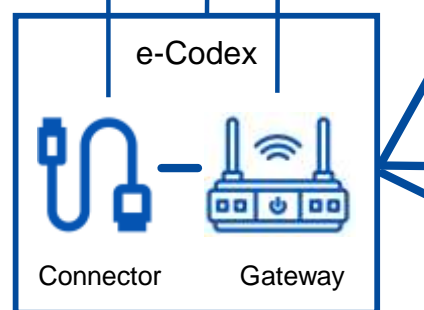

**MS 1 National Domain**



Internet

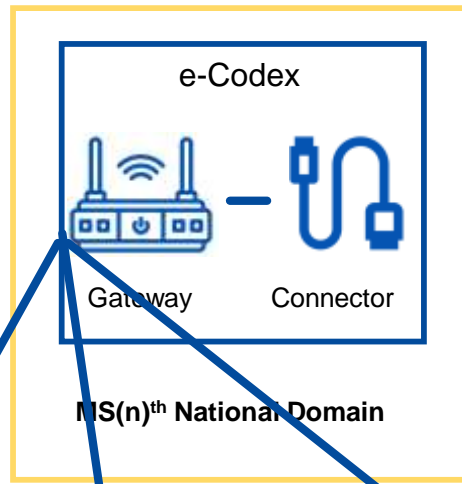

**MS(n)<sup>th</sup> National Domain**

**e-CODEX Network = Authorized e-CODEX Access Points by MS**

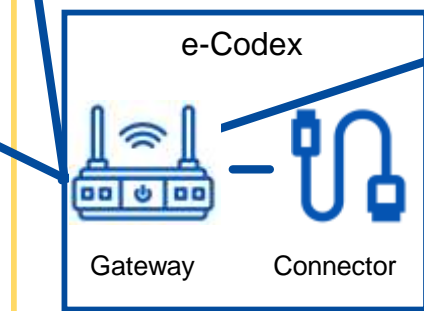

**MS 2 National Domain**

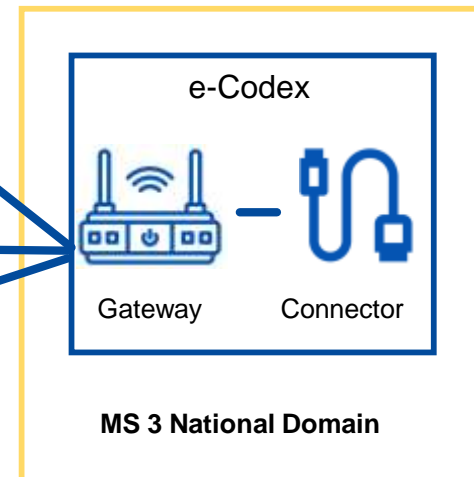

**MS 3 National Domain**

**MS Full Responsibility Operations/Maintenance – Support to MS: eu-LISA**



# A Digital Exchange System

e-Delivery Gateway – Secure Transmission – **DIGIT**

e-CODEX Connector – **eu-LISA** – connects Reference Implementation or National Systems

e-CODEX Access Point = Connector + Gateway  
**eu-LISA**

User interface, **MS** Develop, Operate, Maintain

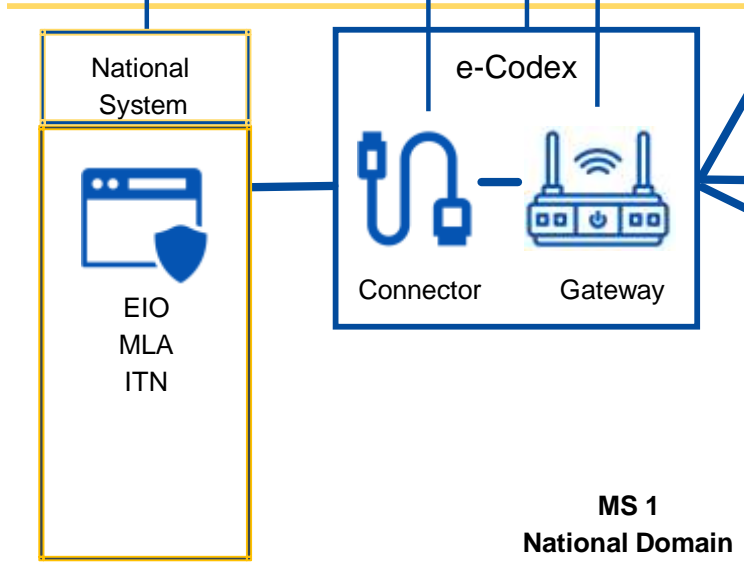
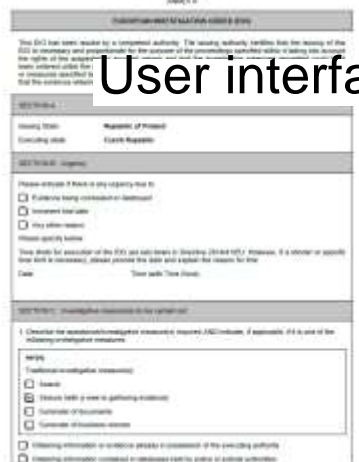

Internet / AS4

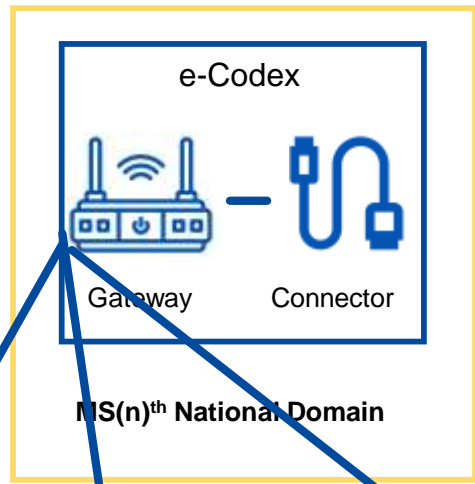

**e-CODEX Network = Authorized e-CODEX Access Points by MS**

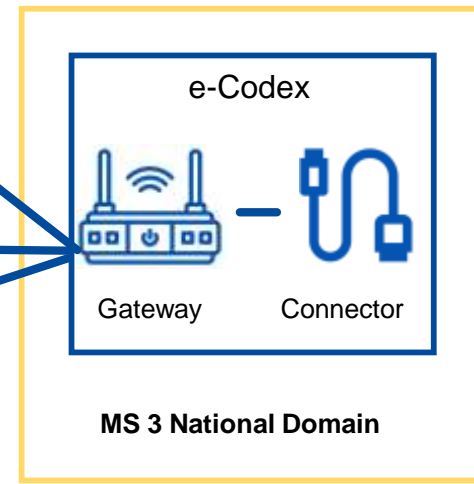
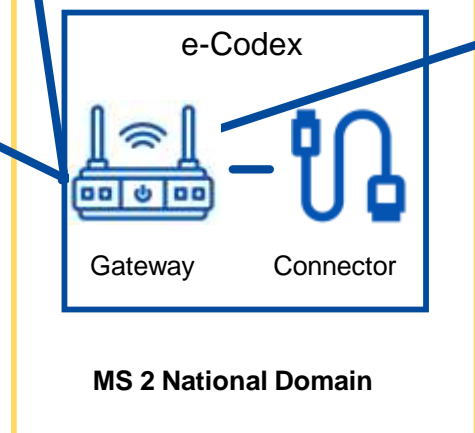

**MS** Full Responsibility Operations/Maintenance – Support to MS: **eu-LISA**



# A Digital Exchange System

e-Delivery Gateway– Secure Transmission – **DIGIT**

e-CODEX Connector – **eu-LISA** – connects Reference Implementation or National Systems

e-CODEX Access Point = Connector + Gateway  
**eu-LISA**

User interface, **MS** Develop, Operate, Maintain

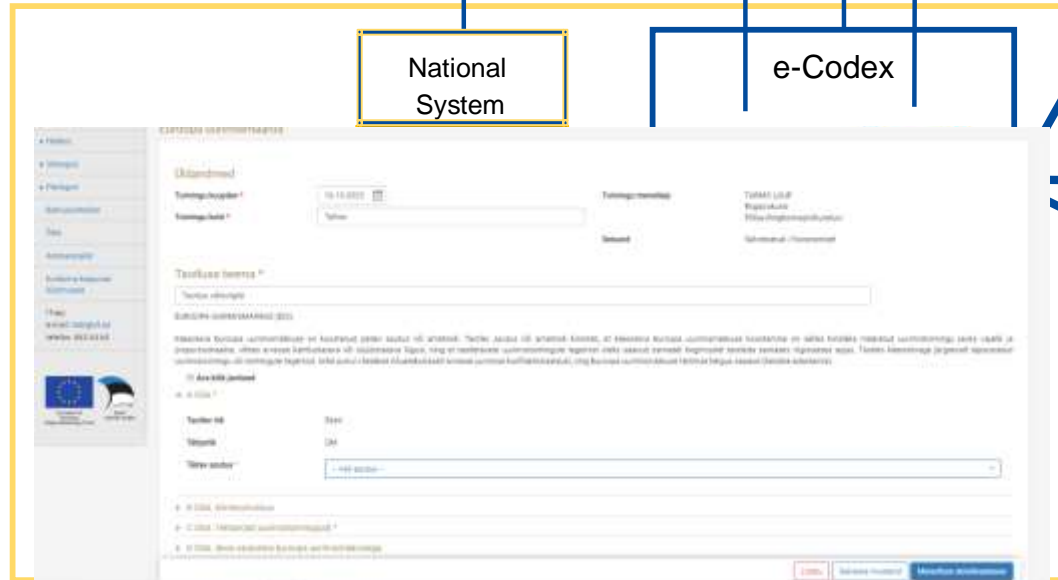

**MS** Full Responsibility Operations/Maintenance – Support to MS: **eu-LISA**



Internet / AS4

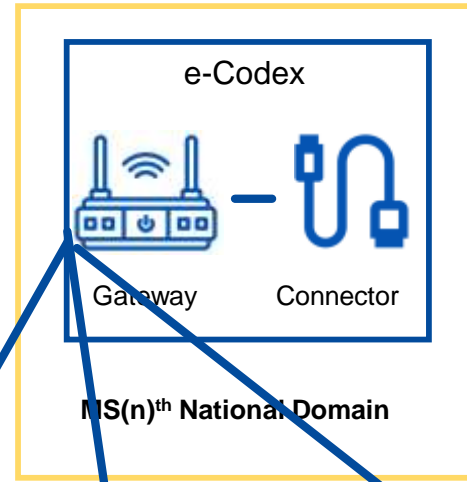

**e-CODEX Network = Authorized e-CODEX Access Points by MS**

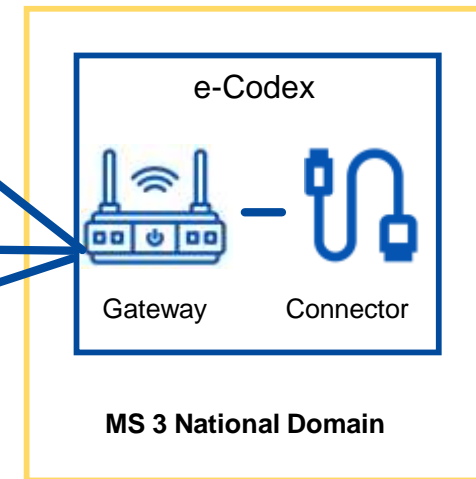
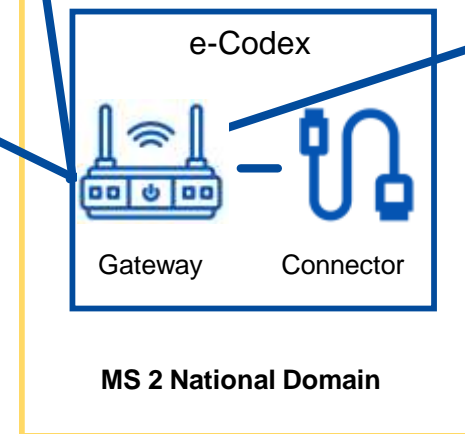



# A Digital Exchange System

e-Delivery Gateway – Secure Transmission – **DIGIT**

e-CODEX Connector – **eu-LISA** – connects Reference Implementation or National Systems

e-CODEX Access Point = Connector + Gateway  
**eu-LISA**

User interface, **JUST** Develops, **MS** Operate

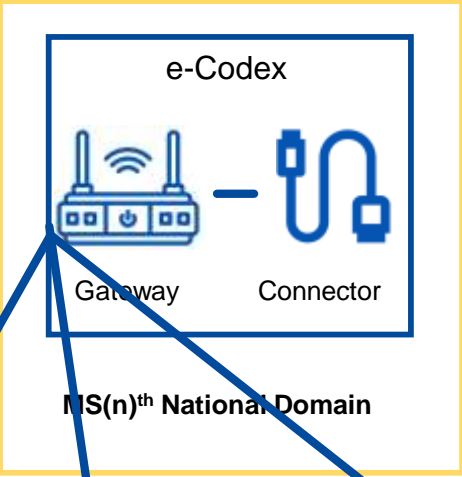
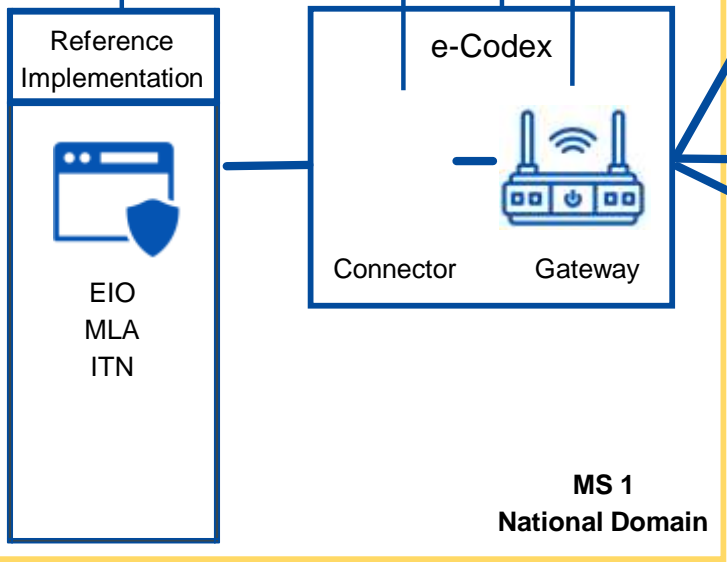

Internet

e-CODEX Network = Authorized e-CODEX Access Points by MS

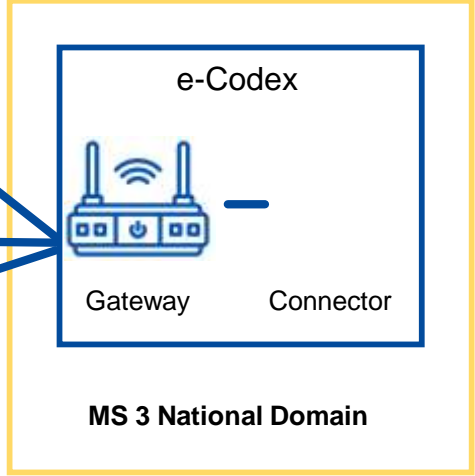
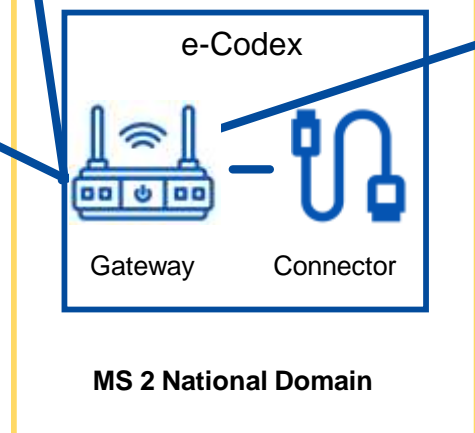

MS Full Responsibility Operations/Maintenance – Support to MS: **eu-LISA**



# A Digital Exchange System

e-Delivery Gateway – Secure Transmission – **DIGIT**

e-CODEX Connector – **eu-LISA** – connects Reference Implementation or National Systems

e-CODEX Access Point = Connector + Gateway  
**eu-LISA**

User interface, **JUST** Develops, **MS** Operate

The screenshot shows a web browser window with the URL `pl.demo.eev.fscatos-services.net/drafts/case/2a906b69-73e2-4746-a8a4-c40170de315b/eio/annex_a`. The interface includes a sidebar with navigation options like 'Start new request', 'Dashboard', 'Issued requests', 'Received requests', and 'Drafts'. The main content area is titled 'EIO' and contains a form with sections: SECTION A (Overview), SECTION B (Urgency), SECTION C (Investigative measure(s)), SECTION D (Related to an earlier EIO), SECTION E (Identity of the person concerned), and SECTION F (Type of proceedings). There are also buttons for 'Copy Case', 'Delete Case', 'Comment', and 'Workflow'.

Reference Implementation

e-Codex

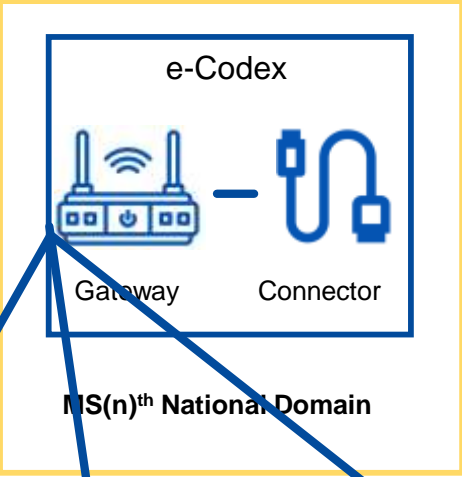

e-CODEX Network = Authorized e-CODEX Access Points by MS

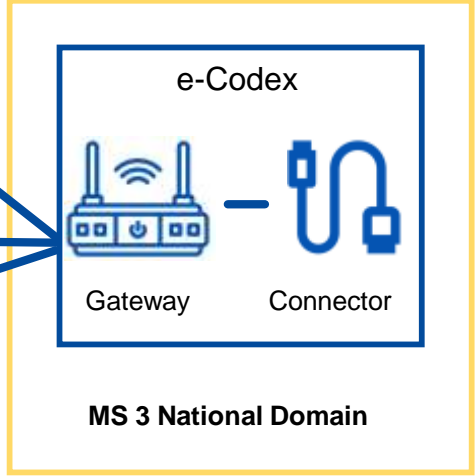
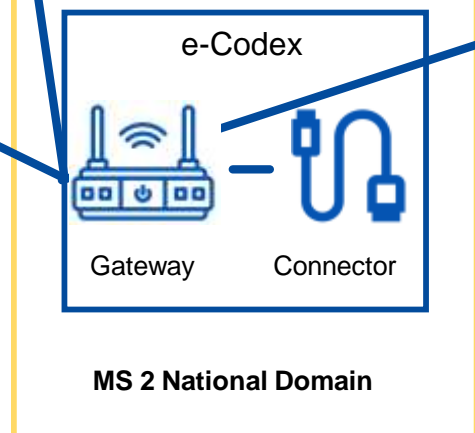

MS Full Responsibility Operations/Maintenance – Support to MS: **eu-LISA**



# eEDES Architecture and Interoperability

**AT, BE, DE, ES, FR, HU, LU, LV, PL, SI**  
(as of October 2023)

**JUST responsible RI + e-CODEX work together**

**MS Full Responsibility Operations/Maintenance – Support to MS: eu-LISA + JUST**

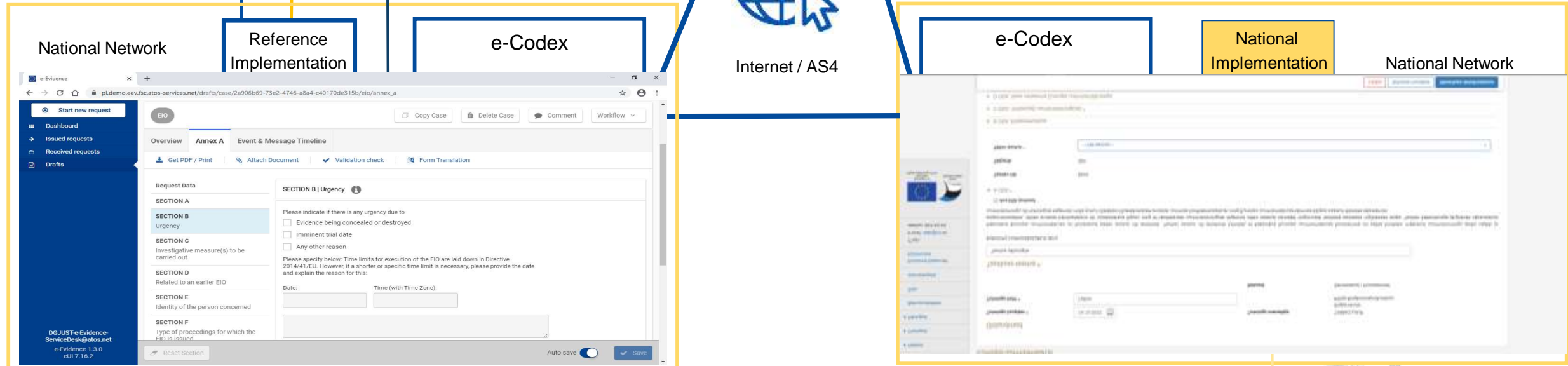

**PT, future EE**

**National CMS - MS Develops, Operates, Maintains**

# What is a Reference Implementation?

# What is a Reference Implementation portal?

A user interface, distributed as a portal, that is able to support the basic workflows of a cross-border judicial procedure, in the all EU languages.

How it looks like?

# Log In

Username or email

Password

Log In

# eEDES Criminal Instruments

The screenshot displays the eEDES Criminal Instruments web application interface. At the top, the European Commission logo and the text "e-Evidence Digital Exchange System" are visible. The user's name, "Filip Wazystkowy", is shown in the top right corner. The main dashboard area is titled "My Dashboard" and features a table of "Last edited cases". A modal window titled "Prepare request" is open, showing a "Start a new request" form with a dropdown menu for "Type of Request\*". The dropdown menu lists various request types, with "European Investigation Order" selected. A yellow arrow points to the "Start new request" button in the left sidebar.

European Commission | e-Evidence Digital Exchange System

Filip Wazystkowy

Automatic translation

Start new request

Dashboard

Issued requests

Received requests

Drafts

My Dashboard

Last edited cases

Issued requests 4205 Received requests

14/02/2022 EIO-CZ-PL-2022-02-14-0001-1

04/02/2022 MLA-CZ-PL-2022-02-04-0001-1

04/02/2022 EIO-CZ-PL-2022-02-04-0001-1

04/02/2022 MLA-CZ-PL-2022-02-04-0002-1

04/01/2022 MLA-CZ-PL-2022-01-04-0002-1

22/12/2021 MLA-CZ-PL-2021-12-22-0002-1

21/12/2021 MLA-CZ-PL-2021-12-21-0001-1

17/12/2021 EIO-CZ-PL-2021-12-17-0001-1

03/12/2021 MLA-CZ-PL-2021-12-03-0001-1 tet cz-pl

26/11/2021 MLA-CZ-PL-2021-11-26-0004-1 timeout v8

marcin.wozniak@afos.net

e-Evidence 2.1.3

eUI 7.10.2

Prepare request

Start a new request

Type of Request\*

- European Investigation Order
- European Investigation Order
- Mutual Legal Assistance
- Interception of Telecommunication Notification (Annex C)
- Joint Investigation Team Agreement
- European Arrest Warrant
- Freezing Order - under Regulation (EU) 2018/1805
- Freezing Order - under Council Framework Decision 2006/577/JHA
- Confiscation Order - under Regulation (EU) 2018/1805
- Confiscation Order - under Council Framework Decision 2006/783/JHA
- Financial Penalties
- Custodial Sentences or Measures Involving Deprivation of Liberty
- Probation Measures and Alternative Sanctions
- European Supervision Order
- Prevention and Settlement of Conflicts of Jurisdiction

My tasks

ITN 01/08/2020 01:32 Sign

EIO 01/08/2020 02:15 Review

EIO 01/08/2020 02:38 Review

EIO 01/08/2020 02:45 Send

EIO 01/08/2020 02:55 Complete

EIO 01/08/2020 03:10 Review

EIO 01/08/2020 03:25 Complete

EIO 01/08/2020 03:39 Send

EIO 01/08/2020 03:44 Send

EIO 01/08/2020 03:48 Sign



# eEDES Civil Instruments

The screenshot displays the user interface of the eEDES Civil Instruments system. At the top, the European Commission logo and the text 'e-Evidence Digital Exchange System' are visible. The user's name, 'Filip Wszystkowy', is in the top right corner. A yellow arrow points to the 'Start new request' button in the left sidebar. The main area shows a 'My Dashboard' with a table of 'Last edited cases'. A 'Prepare request' dialog box is open, showing a dropdown menu for 'Type of Request\*' with 'Service of Documents (Recast) (SoD)' selected. The table below the dialog lists various cases with their dates, IDs, and statuses.

Issued requests	Received requests
14/02/2022	EIO-CZ-PL-2022-02-14-0001-1
04/02/2022	MLA-CZ-PL-2022-02-04-0001-1
04/02/2022	EIO-CZ-PL-2022-02-04-0001-1
04/02/2022	MLA-CZ-PL-2022-02-04-0002-1
04/01/2022	MLA-CZ-PL-2022-01-04-0002-1
22/12/2021	MLA-CZ-PL-2021-12-22-0002-1
21/12/2021	MLA-CZ-PL-2021-12-21-0001-1
17/12/2021	EIO-CZ-PL-2021-12-17-0001-1
03/12/2021	MLA-CZ-PL-2021-12-03-0001-1
26/11/2021	MLA-CZ-PL-2021-11-26-0004-1

- Start new request
- Dashboard
- Issued requests
- Received requests
- Drafts

### My Dashboard

Last edited cases

Issued requests <span>3</span>		Received requests <span>2</span>		Drafts <span>7</span>	
12/06/2020	MLA-PL-HU-2020-06-12-0001-1	Tom MLA 12.06.2020	HU	MLA	Issued
12/06/2020	ITN-PL-HU-2020-06-12-0001-1	Tom ITN 12.06.2020	HU	ITN	Issued
07/06/2020	EIO-PL-CZ-2020-06-07-0001-1	Fusce venenatis sagittis fermentum	CZ	EIO	Issued

#### My tasks

EIO 07/06/2020 00:33	
EIO 08/06/2020 15:05	
EIO 08/06/2020 15:40	
ITN 09/06/2020 13:48	
MLA 15/06/2020 15:36	
ITN 15/06/2020 15:50	



# e-Evidence Digital Exchange System

- Start new request
- Dashboard
- Issued requests
- Received requests
- Drafts

## My Dashboard

Last edited cases

Issued requests		Received requests		Drafts	
3		2		8	
07/06/2020	EIO-PL-CZ-2020-06-07-0001-1	Fusce venenatis sagittis fermentum	CZ	EIO	
12/06/2020	MLA-PL-HU-2020-06-12-0001-1	Tom MLA 12.06.2020	HU	MLA	
12/06/2020	ITN-PL-HU-2020-06-12-0001-1	Tom ITN 12.06.2020	HU	ITN	

## Notifications

Mark all as read Close >

- 11:03 15/06/2020 **KI 15.06-01**  
A new request has been received
- 09:13 15/06/2020 **deadline screens**  
A new request has been received
- 19:12 12/06/2020 **Tom MLA 12.06.2020**  
A new request has been received
- 19:12 12/06/2020 **Tom MLA 12.06.2020**  
A new request has been received
- 19:11 12/06/2020 **Tom MLA 12.06.2020**  
Unable to send a message. Please try resending it.
- 18:47 12/06/2020 **Tom ITN 12.06.2020**  
A new request has been received
- 15:39 08/06/2020 **Fusce venenatis sagittis fermentum**  
A new request has been received
- 15:38 08/06/2020 **Fusce venenatis sagittis fermentum**  
A new request has been received
- 15:07 08/06/2020 **Fusce venenatis sagittis fermentum**  
A new request has been received

- Start new request
- Dashboard
- Issued requests
- Received requests
- Drafts

EIO

Copy Case   Delete Case   Comment   Workflow

Overview   **Annex A**   Event & Message Timeline

Get PDF / Print   Attach Document   Validation check   Form Translation

Request Data

SECTION A

**SECTION B**

Urgency

SECTION C

Investigative measure(s) to be carried out

SECTION D

Related to an earlier EIO

SECTION E

Identity of the person concerned

SECTION F

Type of proceedings for which the EIO is issued

**SECTION B | Urgency** ⓘ

Please indicate if there is any urgency due to

- Evidence being concealed or destroyed
- Imminent trial date
- Any other reason

Please specify below: Time limits for execution of the EIO are laid down in Directive 2014/41/EU. However, if a shorter or specific time limit is necessary, please provide the date and explain the reason for this:

Date:    Time (with Time Zone):

Reset Section

Auto save

Save

- Start new request
- Dashboard
- Issued requests
- Received requests
- Drafts

EIO EIO-PL-CZ-2020-06-07-0001-1

Copy Case Comment Workflow

- Overview
- Annex A
- Annex A Amendment
- Event & Message Timeline

ISSUING STATE	Republic of Poland	EXECUTING STATE	Czech Republic
ISSUING AUTHORITY	Ministerstwo Sprawiedliwosci (Departament Współpracy Międzynarodowej i Praw Człowieka)	EXECUTING AUTHORITY	Krajské státní zastupitelství Praha
Decision: -   ?   B   O			

Status ISSUED **AMENDMENT IN PROGRESS** Linked cases [+ Add case link](#)

Request started on: 07/06/2020 00:21 No cases linked

Latest update on: 08/06/2020 15:40

Assigned users [+ Edit users](#)

AUTHOR	REVIEWER	SIGNER 1	SIGNER 2	SENDER
Filip Wszystkowy	Filip Wszystkowy	Filip Wszystkowy	Filip Wszystkowy	Filip Wszystkowy
radek borecki				

# Roadmap for eEDES

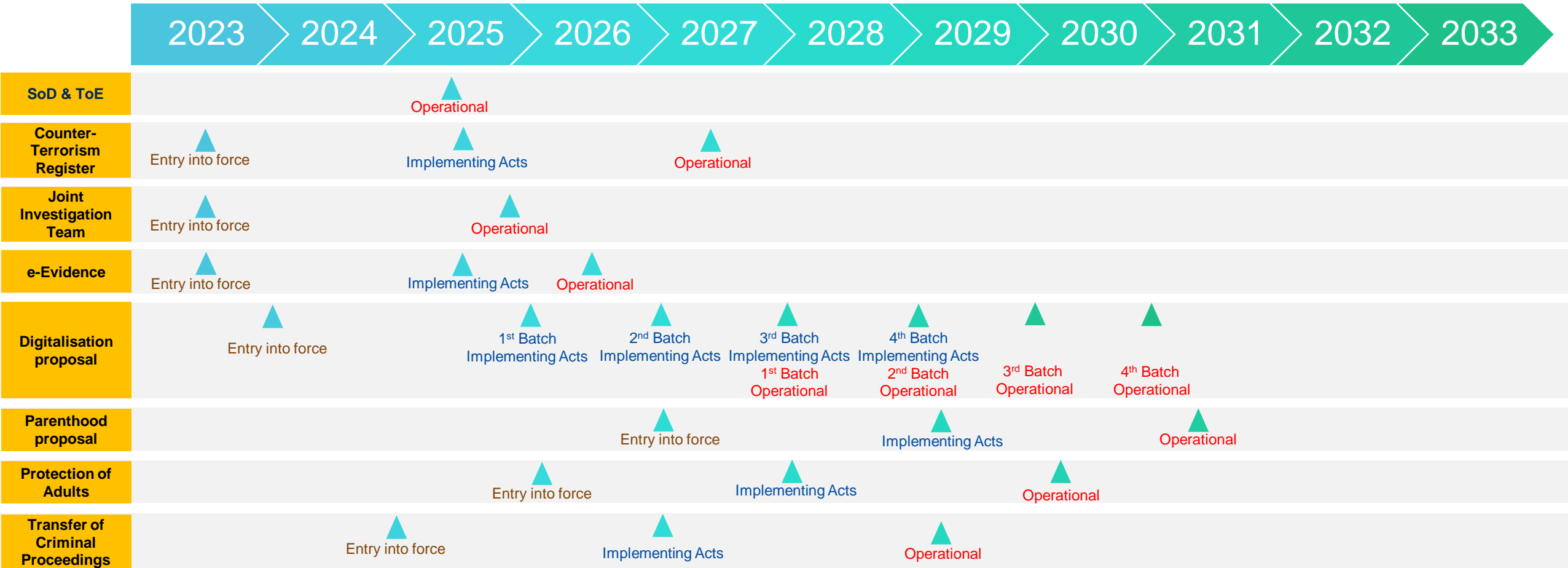

## 1st Batch

- Regulation (EC) No 1896/2006 of the European Parliament and of the Council of 12 December 2006 creating a European order for payment procedure. (EOP)
- Regulation (EC) No 861/2007 of the European Parliament and of the Council of 11 July 2007 establishing a European Small Claims Procedure. (SC)
- Council Framework Decision 2002/584/JHA of 13 June 2002 on the European arrest warrant and the surrender procedures between Member States. (EAW)
- Directive 2014/41/EU of the European Parliament and of the Council of 3 April 2014 regarding the European Investigation Order in criminal matters. (EIO)
- Regulation (EU) 2018/1805 of the European Parliament and of the Council of 14 November 2018 on the mutual recognition of freezing orders and confiscation orders. (FCO)

## 2nd Batch

- Council Directive 2003/8/EC of 27 January 2003 to improve access to justice in cross-border disputes by establishing minimum common rules relating to legal aid for such disputes. (Legal Aid)
- Regulation (EU) No 606/2013 of the European Parliament and of the Council of 12 June 2013 on mutual recognition of protection measures in civil matters (Protection measures-civil matters).
- Regulation (EU) No 655/2014 of the European Parliament and of the Council of 15 May 2014 establishing a European Account Preservation Order procedure to facilitate cross-border debt recovery in civil and commercial matters. (EAPD)
- Regulation (EU) 2015/848 of the European Parliament and of the Council of 20 May 2015 on insolvency proceedings. (Insolvency)
- Council Framework Decision 2008/909/JHA of 27 November 2008 on the application of the principle of mutual recognition to judgments in criminal matters imposing custodial sentences or measures involving deprivation of liberty for the purpose of their enforcement in the European Union. (Custodial sentences)
- Directive 2011/99/EU of the European Parliament and of the Council of 13 December 2011 on the European protection order. (Protection order)

## 3rd Batch

- Regulation (EU) No 650/2012 of the European Parliament and of the Council of 4 July 2012 on jurisdiction, applicable law, recognition and enforcement of decisions and acceptance and enforcement of authentic instruments in matters of succession and on the creation of a European Certificate of Succession. (Successions)
- Council Regulation (EU) 2016/1103 of 24 June 2016 implementing enhanced cooperation in the area of jurisdiction, applicable law and the recognition and enforcement of decisions in matters of matrimonial property regimes. (Matrimonial property regimes)
- Council Regulation (EU) 2016/1104 of 24 June 2016 implementing enhanced cooperation in the area of jurisdiction, applicable law and the recognition and enforcement of decisions in matters of the property consequences of registered partnerships. (Registered partnerships)
- Council Framework Decision 2003/577/JHA of 22 July 2003 on the execution in the European Union of orders freezing property or evidence. (Freezing order)
- Council Framework Decision 2005/214/JHA of 24 February 2005 on the application of the principle of mutual recognition to financial penalties. (Financial penalties)
- Council Framework Decision 2006/783/JHA of 6 October 2006 on the application of the principle of mutual recognition to confiscation orders. (Confiscation orders)
- Council Framework Decision 2009/948/JHA of 30 November 2009 on prevention and settlement of conflicts of exercise of jurisdiction in criminal proceedings. (Jurisdiction in criminal proceedings)

## 4th Batch

- Regulation (EC) No 805/2004 of the European Parliament and of the Council of 21 April 2004 creating a European Enforcement Order for uncontested claims. (Enforcement orders for uncontested claims EEO)
- Council Regulation (EC) No 4/2009 of 18 December 2008 on jurisdiction, applicable law, recognition and enforcement of decisions and cooperation in matters relating to maintenance obligations. (Maintenance obligations)
- Regulation (EU) No 1215/2012 of the European Parliament and of the Council of 12 December 2012 on jurisdiction and the recognition and enforcement of judgments in civil and commercial matters (recast). (Brussels Ia)
- Regulation (EU) 2019/1111 of 25 June 2019 on jurisdiction, the recognition and enforcement of decisions in matrimonial matters and the matters of parental responsibility, and on international child abduction. (Brussels IIb)
- Council Framework Decision 2008/947/JHA of 27 November 2008 on the application of the principle of mutual recognition to judgments and probation decisions with a view to the supervision of probation measures and alternative sanctions. (Alternative sanctions)
- Council Framework Decision 2009/829/JHA of 23 October 2009 on the application, between Member States of the European Union, of the principle of mutual recognition to decisions on supervision measures as an alternative to provisional detention. (Supervision measures)

# Thank you



© European Union 2020

Unless otherwise noted the reuse of this presentation is authorised under the [CC BY 4.0](https://creativecommons.org/licenses/by/4.0/) license. For any use or reproduction of elements that are not owned by the EU, permission may need to be sought directly from the respective right holders.

Slide xx: [element concerned](#), source: [e.g. Fotolia.com](#); Slide xx: [element concerned](#), source: [e.g. iStock.com](#)

